

MOBELI®

ROTH Sanitärprogramme GmbH
Kohlbergstraße 5
D-72213 Altensteig
Tel +49 (0)7453/9381-0 Fax -23
info@mobeli.de
www.mobeli.de

Mobile grab handles with vacuum safety indicator

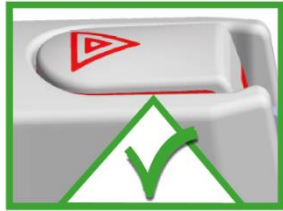

CE

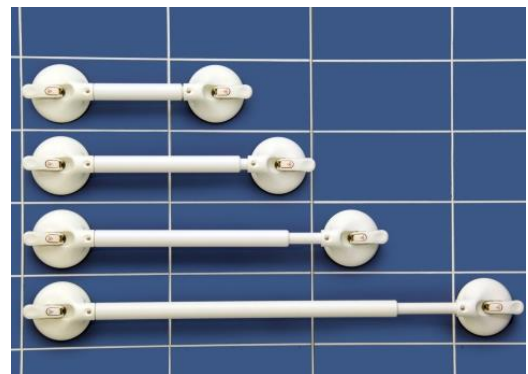
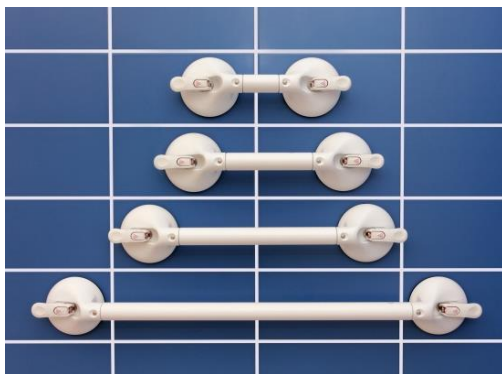

EN

Instruction Manual Mobile grab handles

REF	14002 20S	14002 21S
	14002 25S	14002 22S
	14002 26S/SCL	14002 23S
	14002 27S/SCL	14002 24S
	14002 28S, 14002 29S (KID)	



Table of contents

1.	General	2
1.1	General information	2
1.2	Explanations/symbols in this manual and on the handle	3
1.3	Intended use	3
1.4	Application range of the product	3
1.5	For your information	3
1.6	Useful life	4
1.7	Reuse	4
2.	Safety information	4
3.	Operation / assembly	5
3.1	Mounting (cf. page 9)	5
3.2	Attaching / suction (cf. pages 8 and 10)	5
3.3	Releasing	5
3.4	Disassembling (cf. page 9)	5
4.	Technical data	6
4.1	Markings on the product (for explanations of the symbols, cf. page 2)	6
4.2	Table of technical data	6
4.3	Materials	6
5.	Maintenance	6
5.1	Maintenance (cleaning/disinfection)	6
5.2	Maintenance (service)	7
6.	Recognize and remedying malfunctions	7
7.	Disposal	7
8.	Pictures for operation	8
8.1	Pictures for operation/assembly	8
8.2	Pictures for operation mounting/disassembly	9
8.3	Images of the function of the vacuum safety indicator	10
9.	Accessories	11
10.	Additional products	11

1. General



1.1 General information

Please read this manual carefully before use and follow the safety instructions to ensure your safety when using the mobile grab handle. Keep these instructions for future reference and pass them on to other users!

If the safety rules stated in the instructions for use are not observed, any liability on our part is excluded.

1.2 Explanations/symbols in this manual and on the handle

	Follow the instructions for use!
	For persons with visual impairment, the font size for this on-line manual can be set accordingly at https://www.mobeli.de/download-bereich .
	Warning (indicates a dangerous situation)
	Manufacturer (additionally, year of manufacture on the handlebar)
	Order number
	Maximum user weight
	The mobile MOBELI grab handles are compliant with Regulation (EU) 2017/745
	The mobile MOBELI grab handles are Class I medical devices
	Batch designation



Allergy Notice: The high-quality rubber discs contain natural rubber latex. Natural rubber latex can cause allergic reactions including anaphylactic reactions.

1.3 Intended use



As grab handle or stand-up handle for adults and children. The mobile grab handles have been developed to support natural movement. **They are not designed to carry the full body weight.**

Any other use, e.g. as a seat, carrying handle or climbing aid, is not permitted.

1.4 Application range of the product

As grab handle for largely independent use indoors, as in shower cubicles, bath tubs, toilets, and at washbasins.



For the vacuum suction generated by the rubber pads to be effective, **the grab handle may only be attached** to smooth and non-porous rigid surfaces that are pore- and steam-tight, clean, dry, and free of oils and grease.

On rough or porous surfaces, the vacuum hold will be diminished or does not exist at all. Please bear in mind that tiles are not necessarily always smooth and steam-tight (i.e., suitable for vacuum generation).



Test your tiles and the wall prior to use (with the help of another person, if necessary).

Since the MOBELI vacuum suction pads are made from strongly adhesive and flexible natural rubber, they can usually adapt to slightly textured tiles. (Attention, reduced holding time! Pay attention to the safety indicator!)

The mobile grab handle is ideally suited for use at home where there are no permanently fixed rails, e.g. for short-term use after a stay in hospital or for testing of a new accommodation. It is also well suited at hospitals and nursing homes as an additional and short-term supplement for stationary rails.

The mobile grab handle can also be used where it is not possible to install permanent rails, e.g. in glass shower cubicles or in bathtubs, or if drilling in walls is not allowed (or not possible), e.g. in a rented flat or in a wall where water and/or power lines can be located. Also, during doctor's visitations, office visits, journeys etc., the MOBELI grab handle finds its ideal use.

In addition, the mobile grab handle can be used to determine the optimum position and height for installing fixed rails, i.e., before commencing any drilling and bolting work.

1.5 For your information

In hotels and public establishments in Europe, tiles must be non-porous and steam-tight (as per DIN/EN 159 and 176). According to the tile adhesives material standard DIN 12004, tile adhesives must have a minimum adhesive strength of 0.5 N/mm². E.g., for two tiles with a tile size of 147 mm x 147 mm x 0.5 N/mm², this would result in an

adhesive strength of approx. 2,160 kg. Even with an effective adhesive surface of only 1/3 of the tile surface (e.g., due to a rough serrated trowel) and tile joints not filled-in, there would still be an adhesive strength of approx. 700kg. Unfortunately, though, one cannot always rely on this assumption; therefore, it is absolutely indispensable to test the adhesive strength of the respective tiles or other surface materials on the wall. Furthermore, due to material ageing or in prefabricated construction there might be a reduction of the adhesive strength, therefore testing is essential (e.g., by abrupt application of force; with the help of another person, if necessary).

1.6 Useful life

The expected useful life is six years (if used daily and in accordance with the intended purpose) in an institution or public facility. The prerequisite for this is compliance with the maintenance and safety regulations specified in these operating instructions.

The actual service life may vary depending on the frequency and intensity of use. These handles have been tested according to ISO 17966:2016.

1.7 Reuse

The product is suitable for repeated use. How often the product can be used depends on the type of use. Clean and disinfect the product thoroughly before re-use and check the handle carefully, especially the function of the vacuum safety indicator.

2. Safety information



- **Prior to any use of the mobile grab bar, the vacuum safety indicator must be examined and acted upon according to the instructions (cf. page 10)**



- **Even on fully impermeable, flush tiles it can never be determined exactly when the vacuum will decrease (e.g. due to hairline cracks), therefore always pay attention to the vacuum safety indicator!**
- Use the mobile grab handle only when you have experience in handling it or while you are under supervision of a person who has experience in its use. Children may only use the handle under supervision or if you have secured the rocker arms with a rocker arm lock (cf. accessories on page 11).
- Before each new attachment, make sure of the proper functioning of the mobile grab handle. Pay particular attention to the rubber suction pads; they must be clean and undamaged and must not show any signs of tearing or scoring.



Never use mobile grab handles with damaged rubber pads and/or with reduced adhesive strength.

- Remember that the suction cup only adheres as well as the substrate, so check the adhesion of the substrate (e.g. the tile on the wall) before using the grab handle in a new place.
- After applying the vacuum tilting levers, the sucking adhesive strength created by the vacuum can be entirely or partly absent, in particular with unglazed tiles, natural stone, wood, as well as ceramic coating that has been textured/grinded or given a rough grain to provide a non-slip finish.
With grab bars with vacuum safety indicator this becomes visible by the rising of the flip-up tab!



- **Attention!** Usage under water reduces the suction strength.
- The suction strength stated above refers to normal room temperature (10 °C – 30 °C); at high temperatures, e.g. in a sauna, the suction strength will be reduced. **Attention!** Temperatures higher than 41 °C can be reached due to solar radiation or by contact with hot water which can lead to skin damage and/or burning.
- The indicated suction strength is calculated at about 300 m above sea level. At higher altitudes, the suction strength diminishes (by approx. 10 % per every additional 1,000 m of altitude).
- Never expose the rubber pads to UV radiation (sunlight) for any prolonged periods of time; otherwise they will quickly lose their elasticity. For this reason, never attach the grab handles to any surface (e.g. window) that will be illuminated from the outside.



- Do not place anything underneath the grab handle that could be damaged by the rail suddenly releasing and dropping on it, or remove the grab handle after use.
- **The detachable mobile grab handles may only be used with the tilting levers perfectly engaged.**
- Do not attach the mobile grab handles to vehicle metal panels, foils, or thin glass panes because the vacuum created by the suction pad might deform and damage these materials.
- If the mobile grab handle remains attached over prolonged periods of time, there is the risk that the underground (e.g. bath tub) gets permanently stained by the rubber pad.



- Never combine MOBELI products with parts from other manufacturers. This will invalidate any warranty or liability. **Risk of accident!!!**

3. Operation / assembly

3.1 Mounting (cf. page 9)

Assembling: Push the snap pins in on both sides of the telescopic bar (fig. 11) and insert the bar into the suction pad housing until the snap pins lock into place in their corresponding holes (clicking sound).



**Test the secure hold of the snap pins by trying to pull the components apart!
The grab handle must not be used if not all snap pins on both sides are securely locked.**

3.2 Attaching / suction (cf. pages 8 and 10)

1. Examine the vacuum suction pads and the surface they are to be attached to.
2. Clean the surface thoroughly (fig. 1) so that it is **clean** (e.g. from etched lime sludge) and **grease-free**. Likewise, the surface of the suction disc must be clean.
3. **Firmly press the mobile grab handles onto the surface where they should be sucked on.** (figs. 3 to 5).
 - a. The **tilting vacuum levers** must be **loose** at this point.
 - b. It must be taken care that both **rubber pads** are always positioned with their **full suction area** on the tiles or other surfaces so that no grouting line or tile joint (figs. 8 and 9) lies under a rubber pad and the pads are attached at least 10 mm above the lower edge of a joint (fig. 2).

With the telescopic grip (order no. 14002-21S, -22S, -23S, -24S), you can adjust the length of the grip to achieve this (figs. 6 and 7).
4. While **pressing the bar against the surface to be adhered to and at the same time pressing on the rocker**, turn over the 1st rocker and then the 2nd rocker (figs. 2, 3, 4, 5, 7).
5. The vacuum safety indicators continuously monitor the current vacuum state.



After the rocker is pressed and turned, the red-coloured safety tab must be **completely recessed flush with the surface** in the rocker (page 10, figs. 13 and 15)! In the course of time when the vacuum decreases, the safety rockers will extend.



- If a red side edge of the safety tabs (figs. 14 and 16) has become visible, the grab bar must not be used under any circumstances and **must be reattached** immediately!
- **The clearer a red side edge of the tabs** (figs. 14 and 16) **can be seen, the lower is the actual adhesive strength!**



6. Check the vacuum safety indicator prior to any use. This can be felt by visually impaired or blind people. If the vacuum safety indicator is not retracted (as just described), reattach the suction pads. If the indicator tabs are still raised after the rocker has been turned and also are still sticking out after the tabs have been pressed, the grab bar must be reattached (cf. malfunctions on page 7).



If retraction of the indicator tabs cannot be achieved, do not use the bar under any circumstances!

3.3 Releasing

1. Put a finger under the vacuum tilting lever in order to raise it; at the same time set your thumb on the structured recess of the vacuum tilting lever to prevent a recoil effect.



Caution! With wrong operation there exists danger of squeezing.

2. Wait a little while! The rubber pads will relax after approx. 30–60 seconds and return to their original shape, and then the suction device can be removed from the wall. Should the rubber pads keep adhering longer, you can additionally raise the pads at one side (between wall and rubber disc) with a finger so that air can penetrate underneath.



3. **Do not try to loosen the rubber pads with sharp edged items or tools; you would damage them.**
4. When not in use, store the mobile grab handle with the rubber pads relaxed (i.e., with vacuum tilting levers disengaged), flat and plane. Protect your mobile grab handle (e.g. in the box) from UV rays.

3.4 Disassembling (cf. page 9)

Disassembling: Push the snap pins in (fig. 10), and while holding the suction housing pull the telescopic bar out of it (fig.11). Store the suction housings with the tilting levers pointing upward on a flat surface.

(Page 9 fig. 12)

4. Technical data

4.1 Markings on the product (for explanations of the symbols, cf. page 2)



At the back of the handlebar (C)



 ROTH GmbH D-72213 Altensteig Jahr
MOBELI.de **REF** 140022XS **LOT** XX

At the top of the handlebar (D)



 max. XX kg  

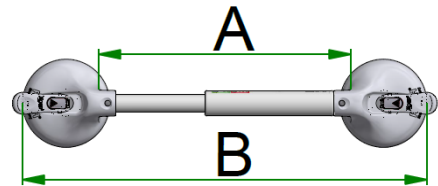
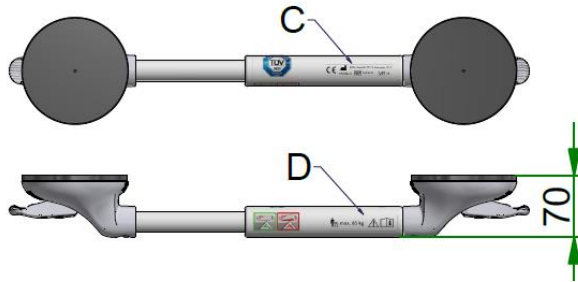

Maximum user weights in the table of technical data and on the handle bar must be observed! The mobile grab handles have been developed to support natural movement. They are not designed to carry the full body weight.

4.2 Table of technical data



REF ROTH order no.	Grip length A (adjustable for telescopic grips) in mm	Total length B in mm	Grip Ø in mm	Max. user weight in kg	Max. user weight in lbs	Product weight in kg
14002 20S	110	330	35	105	230	0.76
14002 21S	220-345	440-565	35/24	85	187	0.89
14002 22S	340-465	560-685	35/24	85	187	1.02
14002 23S	440-565	660-785	35/24	85	187	1.13
14002 24S	665-790	885-1010	35/24	80	176	1.37
14002 25S	210	430	35	100	220	0.85
14002 26S/ SCL	350	570	35	95	208	1.01
14002 27S/ SCL	650	870	35	95	208	1.33
14002 28S	170	430	26	75	165	0.79
14002 29S	310	570	26	75	165	0.88

4.3 Materials

Handle bar made of high-impact PVC, all metal parts made of stainless-steel
Suction disc made of NBR, suction casing made of PA 6.6

5. Maintenance

5.1 Maintenance (cleaning/disinfection)

- Clean the handle with a cloth using standard household detergents such as soapy water, but do not use abrasive or aggressive cleaning agents. Do not use thinner or petrol and do not use detergents that attack plastics.
- Rinse the handle thoroughly with warm water until all soap and foam residues have been removed. (Otherwise rust can adhere to the stainless-steel parts.)

- Keep the rubber pad always free from oil, dust, and dirt by rinsing with warm water and then drying with a lint-free cloth.
- Disinfect the product by wiping all surfaces with a cloth with disinfectant.
- In a medical environment, also refer to the "Recommendations of the Commission for Hospital Hygiene and Infection Prevention" on the website of the Robert Koch Institute www.rki.de.
- The grab handle is resistant to the active agents in the hand and surface disinfectants certified by the DGHM (Disinfection Commission of the German Society for Hygiene and Microbiology) with the exception of phenol ether, pyridine derivative, and thiocyanate.
- **Only alcoholic disinfection without re-fattening component may be used for the rubber discs.**



5.2 Maintenance (service)

- If the handle has been attached to the wall for a prolonged period of time, the rubber discs will overstretch. We therefore recommend that you remove the handle from the wall approx. every 14 days and leave it overnight on a flat surface with the rubber washers relaxed, then reattach it the next morning.
- Examine the rubber pads for possible functional deterioration because of reduced elasticity due to age, wear, exposure to sunlight, uneven storage, scoring, etc.
If the rubber pads are damaged and therefore the adhesive strength is limited, the complete suction heads (spare part no. 14002S) are to be replaced or the rubber pads (spare part no. 1402721) must be exchanged by trained specialist staff.
- Keep the vacuum safety indicator always free from dirt!!
- **Check the handle regularly for damage and do not use the handle under any circumstances if it is damaged.**



6. Recognize and remedying malfunctions

Malfunctions	Possible causes of malfunctions/test	Corrective measures
With new handle: safety indicator pops up after a short time	Lime or other dirt on the surface.	Clean the surface thoroughly.
	The surface is not non-porous even if it looks smooth, or it is damaged (e.g. hairline crack in the tile). Possible test procedure: Attach the handle to a glass pane or mirror and pay attention to the safety indicator. If now the safety indicator does not move any more, the fault is in the substrate.	If possible, attach the handle at another location where the underground is non-porous. If this is not possible, self-adhesive stainless-steel plates (order no. 1461414) to which the handles can be attached can be glued on. See accessories.
With older handle: safety indicator pops up after a short time	Rubber discs scratched or damaged.	If there is damage, the rubber discs (order no. 1402721) can be replaced by a specialist dealer or the complete suction head (order no. 14002S) can be replaced.
Indicator rocker is still slightly raised after mounting	1. Toggle lever not firmly pressed down before turning over!	Attach the handle again while beforehand pressing the rocker arm firmly down. (Page 8 fig. 3 arrow 2)
	2. The rubber pad is overstretched. This happens when the handle has been attached to the wall for a long time.	Store the handle overnight on a flat surface with the rocker arm pointing upwards. (Page 9 fig. 12). Attach again the next day while beforehand pressing the rocker arm firmly down. If the mounting rocker still protrudes after pressing it in, the rubber discs (order no. 1402721) must be replaced by a specialist dealer or the complete suction head (order no. 14002S) must be replaced.
	<div style="border: 1px solid black; padding: 5px; display: inline-block;">Video attach grab handle</div> 	

7. Disposal

The product packaging should be recycled. The metal parts can be recycled as scrap metal. Disposal must be carried out according to the respective national statutory regulations. Please ask your local or communal authority about local disposal facilities.

These ROTH mobile grab handles may not be exported to the U.S. (cf. U.S. version).

Subject to technical modification.

8. Pictures for operation

8.1 Pictures for operation/assembly

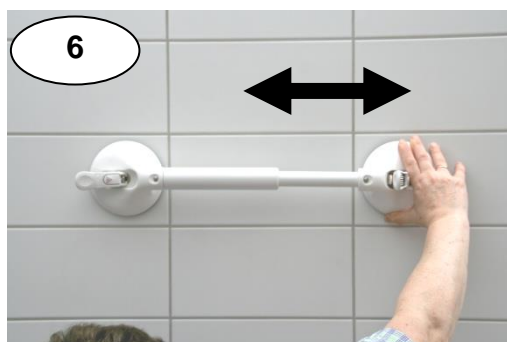
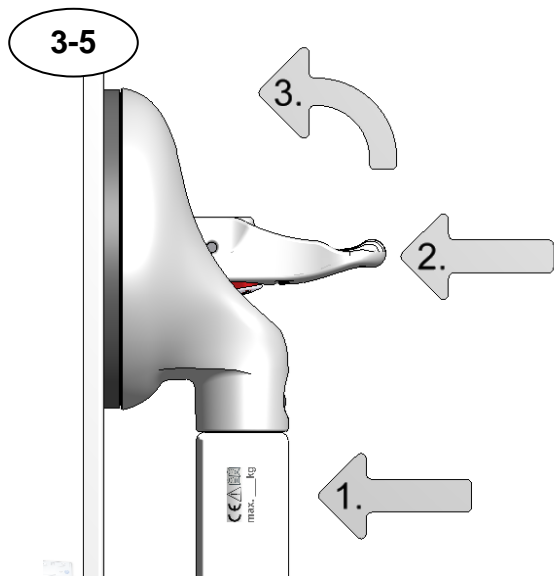

1400221S; 1400222S; 1400223S; 1400224S

8.2 Pictures for operation mounting/disassembly

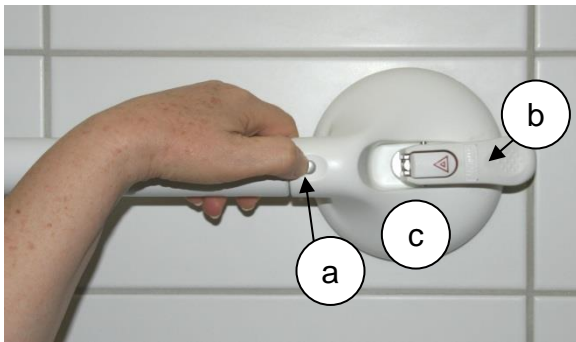

REF 14002S

MOBELI.COM
D-72213 Altensteig

ROTH® Made in Germany

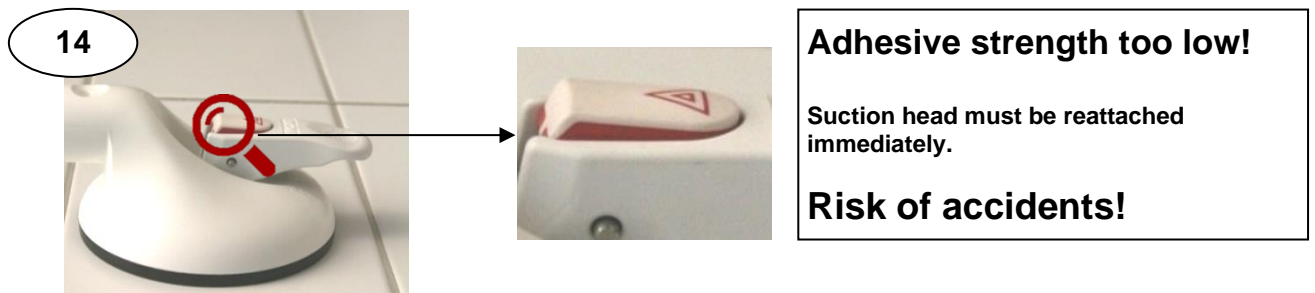
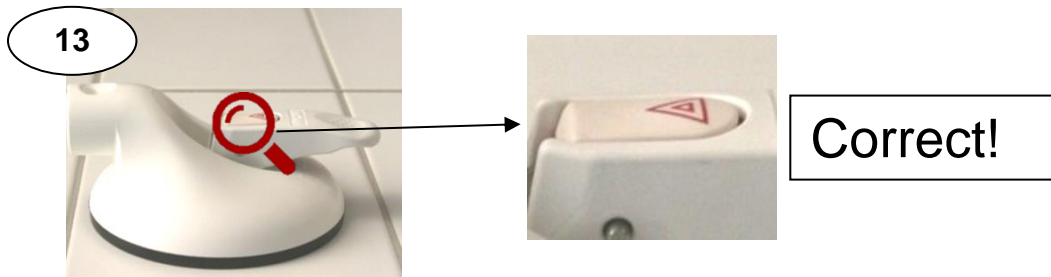

Mode of operation of the safety jack: The vacuum is permanently monitored.

Explanation of the symbols on the grab handles

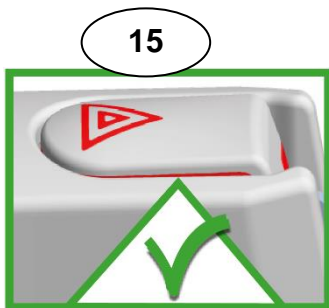

Full security for the specified maximum user weight.

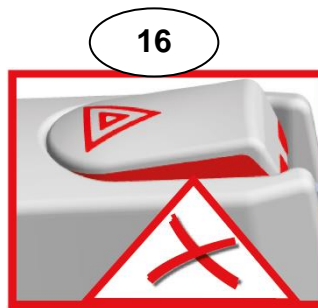

Attention! The handle must be reattached immediately!

The vacuum of the handle is reduced. The handle is no longer permissible for the maximum user weight. (Only for your information: A reduced adhesive strength is still present.)

9. Accessories

Accessories are available from your specialist dealer.

To prevent unauthorised persons (e.g. demented persons, children, or in public areas) from opening the handle, we recommend our rocker arm safety lock.

REF 1400672 (for 2 locks and 1 key).

Video – Tilting lever lock



Angle joint adapter

Order no. 1400558, for use over corner

Rocker arm extension

Order no. 1400574, if the user's strength is insufficient to actuate the rocker arm

Flexible contrast rings

Order no. 1402766, for better contrast for visually impaired persons

Stainless-steel plates

Order no. 1461414, for non-porous tiles

Protective parts

Order no. 1400682, for transport on rough surfaces

Video rocker arm extension



10. Additional products

For higher load requirements we recommend our QuattroPlus!

The QuattroPlus grab handles are designed for a maximum user weight of 160 kg.



Should you require further information and videos about the products, please contact us.

You can also find them on our website: www.mobeli.de

The instructions for use are available in the download area: www.mobeli.de/download-bereich

Video
MOBELI
products



A brand of:



MOBELI®

ROTH Sanitärprogramme GmbH
Kohlbergstraße 5
D-72213 Altensteig
Tel +49 (0)7453/9381-0 Fax -23
info@mobeli.de
www.mobeli.de